

Dell™ M210X Projector

User's Guide

Notes, Notices, and Cautions



NOTE: A NOTE indicates important information that helps you make better use of your projector.



NOTICE: A NOTICE indicates either potential damage to hardware or loss of data and tells you how to avoid the problem.



CAUTION: A CAUTION indicates a potential for property damage, personal injury, or death.

Information in this document is subject to change without notice.

© 2009 Dell Inc. All rights reserved.

Reproduction of these materials in any manner whatsoever without the written permission of Dell Inc. is strictly forbidden.

Trademarks used in this text: *Dell* and the *DELL logo* are trademarks of Dell Inc.; *DLP* and *DLP logo* are trademarks of TEXAS INSTRUMENTS INCORPORATED; *Microsoft* and *Windows* are either trademarks or registered trademarks of Microsoft Corporation in the United States and/or other countries.

Other trademarks and trade names may be used in this document to refer to either the entities claiming the marks and names or their products. Dell Inc. disclaims any proprietary interest in trademarks and trade names other than its own.

Model M210X

October 2009 Rev. A00

Contents

1	Your Dell Projector.....	5
	About Your Projector	6
2	Connecting Your Projector.....	8
	Connecting to a Computer	9
	Connecting a Computer Using a VGA Cable.....	9
	Connecting a DVD Player	10
	Connecting a DVD Player Using an S-video Cable ...	10
	Connecting a DVD Player Using a Composite Video Cable	11
	Connecting a DVD Player Using a Component Video Cable	12
	Connecting a DVD Player Using an HDMI Cable.....	13
3	Using Your Projector.....	14
	Turning Your Projector On	14
	Turning Your Projector Off	14
	Adjusting the Projected Image	15
	Raising the Projector Height.....	15
	Lowering the Projector Height	15
	Adjusting the Projector Zoom and Focus	16
	Adjusting Projection Image Size	17

Using the Control Panel	18
Using the Remote Control	21
Installing the Remote Control Batteries	24
Operating Range With Remote Control	25
Using the On-Screen Display	26
Main Menu	26
AUTO-ADJUST	26
INPUT SELECT	27
PICTURE (in PC Mode)	28
PICTURE (in Video Mode)	28
DISPLAY (in PC Mode)	30
DISPLAY (in Video Mode)	31
LAMP	32
SET UP	32
INFORMATION	34
OTHERS	34
4 Troubleshooting Your Projector	41
Guiding Signals	45
Changing the Lamp	47
5 Specifications	49
6 Contacting Dell	53
7 Appendix: Glossary	54

1

Your Dell Projector

Your projector comes with all the items shown below. Ensure that you have all the items, and contact Dell™ if anything is missing.

Package Contents

Power cable



1.8m VGA cable (VGA to VGA)



Carrying case



Remote control



CD User's Guide & Documentation

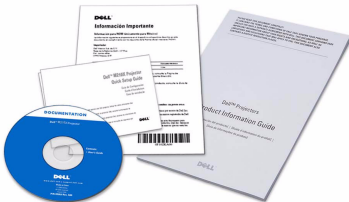

AAA Batteries (2)



About Your Projector

Top View



Bottom View

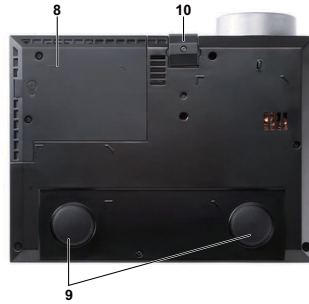

1	Control panel
2	Zoom tab
3	Focus ring
4	Lens
5	Elevator button for height adjustments
6	IR receivers
7	Lens cap
8	Lamp cover
9	Tilt adjustment wheel
10	Elevator foot

CAUTION: Safety Instructions

- 1 Do not use the projector near appliances that generate a lot of heat.
- 2 Do not use the projector in areas where there is an excessive amount of dust. The dust may cause the system to fail and the projector will automatically shutdown.
- 3 Ensure that the projector is mounted in a well-ventilated area.
- 4 Do not block the ventilation slots and openings on the projector.
- 5 Ensure the projector operates between ambient temperatures (5°C to 35°C).
- 6 Do not try to touch the ventilation outlet as it can become very hot after the projector has been turned on or immediately after it is turned off.

7 Do not look into the lens while the projector is on as it may cause injury to your eyes.

8 Do not place any objects near or in front of the projector or cover its lens while the projector is on as the heat may cause the object to melt or burn.



NOTE: For more information, see the *Safety Information* that is shipped with your projector.

2

Connecting Your Projector

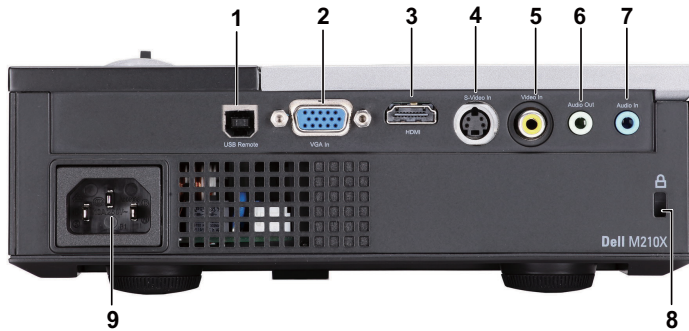

1	USB remote connector	6	Audio output connector
2	VGA input (D-sub) connector	7	Audio input connector
3	HDMI connector	8	Security cable slot
4	S-video connector	9	Power cord connector
5	Composite video connector		



CAUTION: Before you begin any of the procedures in this section, follow the Safety Instructions as described on page 6.

Connecting to a Computer

Connecting a Computer Using a VGA Cable



1	Power cord
2	VGA to VGA cable
3	USB-A to USB-B cable



NOTE: The USB cable is not provided with your projector.



NOTE: The USB cable must be connected if you want to use the Page Up and Page Down features on the remote control.

Connecting a DVD Player

Connecting a DVD Player Using an S-video Cable



1	Power cord
2	S-video cable



NOTE: The S-video cable is not shipped with your projector. You can purchase the S-Video extension (50 ft/100 ft) cable on the Dell website at dell.com.

Connecting a DVD Player Using a Composite Video Cable

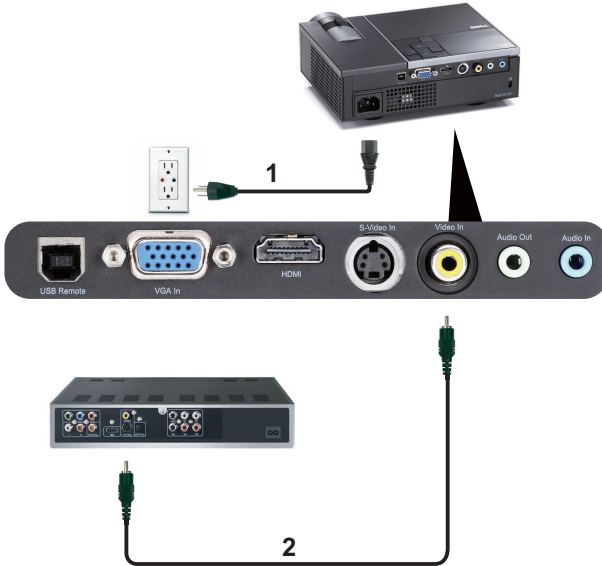

1	Power cord
2	Composite video cable



NOTE: The Composite Video cable is not shipped with your projector. You can purchase the Composite Video Extension (50 ft/100 ft) cable on the Dell website at dell.com.

Connecting a DVD Player Using a Component Video Cable

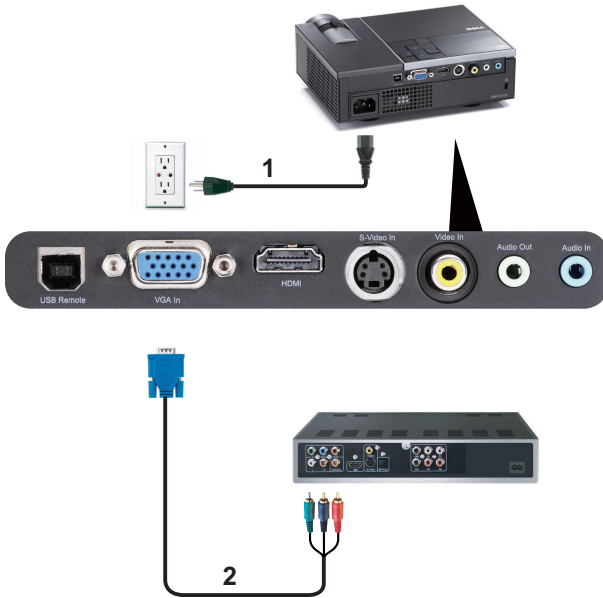

1	Power cord
2	VGA to Component Video cable



NOTE: The VGA to Component Video cable is not shipped with your projector. You can purchase the VGA to Component Video Extension (50 ft/100 ft) cable on the Dell website at dell.com.

Connecting a DVD Player Using an HDMI Cable

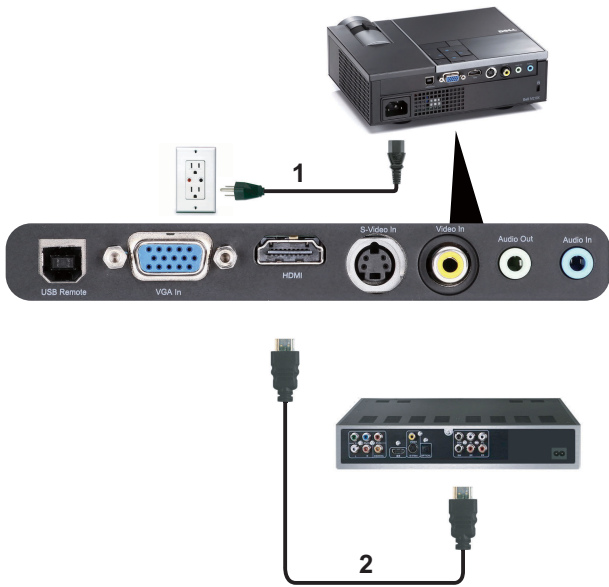

1	Power cord
2	HDMI cable

 **NOTE:** The HDMI cable is not shipped with your projector.

Using Your Projector

Turning Your Projector On

 **NOTE:** Turn on the projector before you turn on the source (computer, DVD player, etc.). The **Power** button light blinks blue until pressed.

- 1 Remove the lens cap.
- 2 Connect the power cord and appropriate signal cables. For information about connecting the projector, see "Connecting Your Projector" on page 8.
- 3 Press the **Power** button (see "Using the Control Panel" on page 18 to locate the **Power** button).
- 4 Turn on your source (computer, DVD player, etc.)
- 5 Connect your source to the projector using the appropriate cable. See "Connecting Your Projector" on page 8 for instructions to connect your source to the projector.
- 6 By default, the input source of projector is set to VGA-In. Change the input source of projector if necessary.
- 7 If you have multiple sources connected to the projector, press the **Source** button on the remote control or control panel to select the desired source. See "Using the Control Panel" on page 18 and "Using the Remote Control" on page 21 to locate the **Source** button.

Turning Your Projector Off

 **NOTICE:** Unplug the projector after properly shutting down as explained in the following procedure.

- 1 Press the **Power** button.

 **NOTE:** The "**Press Power Button to Turn off Projector**" message will appear on the screen. The message disappears after 5 seconds or you can press the **Menu** button to clear it.

- 2 Press the **Power** button again. The cooling fans continue to operate for 120 seconds.

3 To power off the projector quickly, press the **Power** button and hold for 1 second while the projector's cooling fans are still running.

 **NOTE:** Before you turn on the projector again, wait for 60 seconds to allow the internal temperature to stabilize.

4 Disconnect the power cord from the electrical outlet and the projector.

Adjusting the Projected Image

Raising the Projector Height

1 Press the **Elevator** button.

2 Raise the projector to the desired display angle, and then release the button to lock the elevator foot into position.

3 Use the tilt adjustment wheel to fine-tune the display angle.

Lowering the Projector Height

1 Press the **Elevator** button.

2 Lower the projector, and then release the button to lock the elevator foot into position.



1	Elevator button
2	Elevator foot (Angle of tilt: 0 to 9,5 degree)
3	Tilt adjustment wheel

Adjusting the Projector Zoom and Focus

⚠ CAUTION: To avoid damaging the projector, ensure that the zoom lens and elevator foot are fully retracted before moving the projector or placing the projector in its carrying case.

- 1 Rotate the zoom tab to zoom in and out.
- 2 Rotate the focus ring until the image is clear. The projector focuses at distances ranging between 3.28 ft to 39.37 ft (1 m to 12 m).



1	Zoom tab
2	Focus ring

Adjusting Projection Image Size

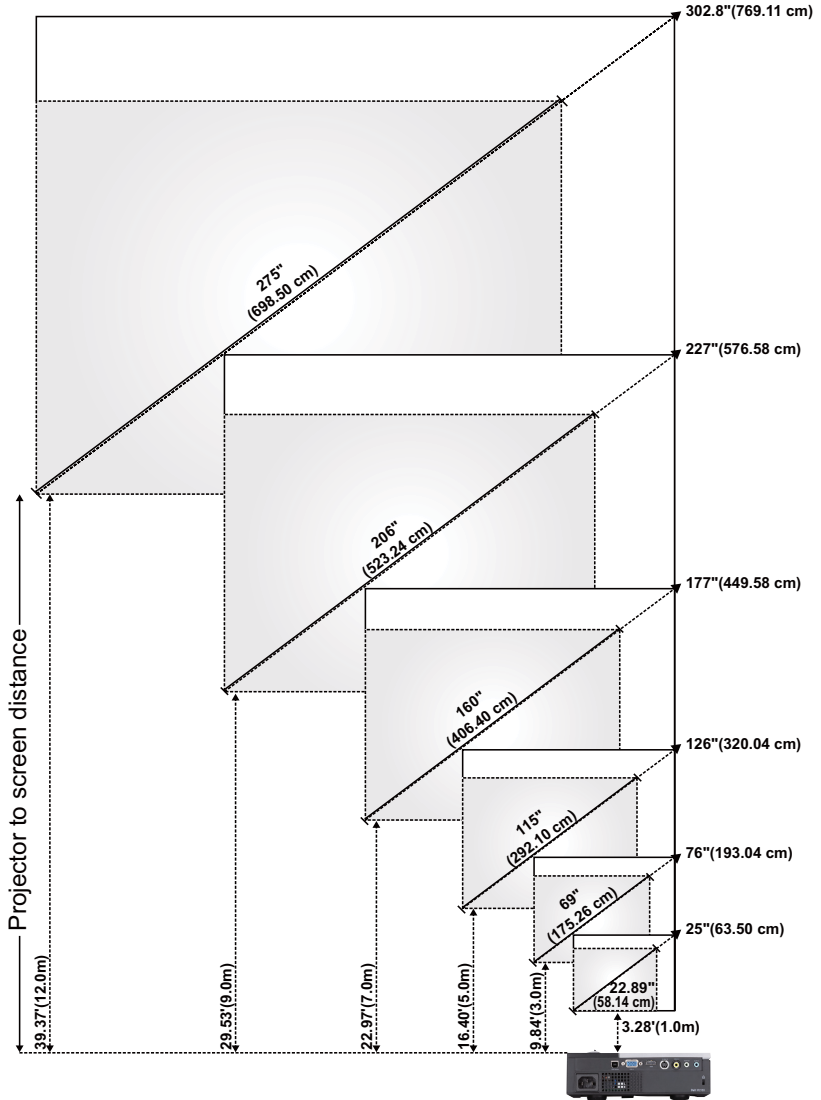





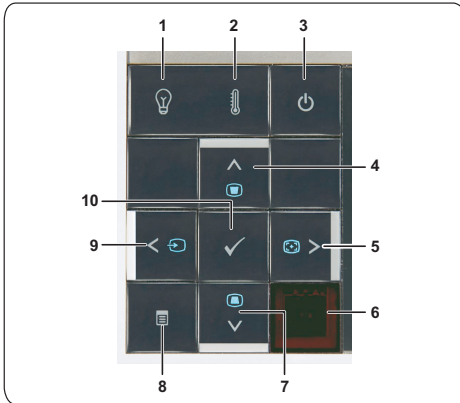

Screen (Diagonal)	Max.	25" (63.50 cm)	76" (193.04 cm)	126" (320.04 cm)	177" (449.58 cm)	227" (576.58 cm)	302.8" (769.11 cm)
	Min.	22.89" (58.14 cm)	69" (175.26 cm)	115" (292.10 cm)	160" (406.40 cm)	206" (523.24 cm)	275" (698.50 cm)
Screen Size	Max. (WxH)	20.08" X 14.96"	60.63" X 45.28"	100.79" X 75.59"	141.34" X 105.91"	181.89" X 136.22"	242.13" X 181.89"
		(51 cm X 38 cm)	(154 cm X 115 cm)	(256 cm X 192 cm)	(359 cm X 269 cm)	(462 cm X 346 cm)	(615 cm X 462 cm)
	Min. (WxH)	18.50" X 13.78"	55.12" X 41.34"	91.73" X 68.50"	128.35" X 96.06"	164.96" X 123.62"	219.69" X 123.62"
		(47 cm X 35 cm)	(140 cm X 105 cm)	(233 cm X 174 cm)	(326 cm X 244 cm)	(419 cm X 314 cm)	(558 cm X 419 cm)
Hd	Max.	17.32" (44 cm)	52.36" (133 cm)	87.01" (221 cm)	122.05" (310 cm)	156.69" (398 cm)	209.06" (531 cm)
	Min.	15.75" (40 cm)	47.24" (120 cm)	79.13" (201 cm)	110.63" (281 cm)	142.13" (361 cm)	189.37" (481 cm)
Distance		3.28' (1.0m)	9.84' (3.0m)	16.40' (5.0m)	22.97' (7.0m)	29.53' (9.0m)	39.37' (12.0m)

* This graph is for user reference only.

Using the Control Panel









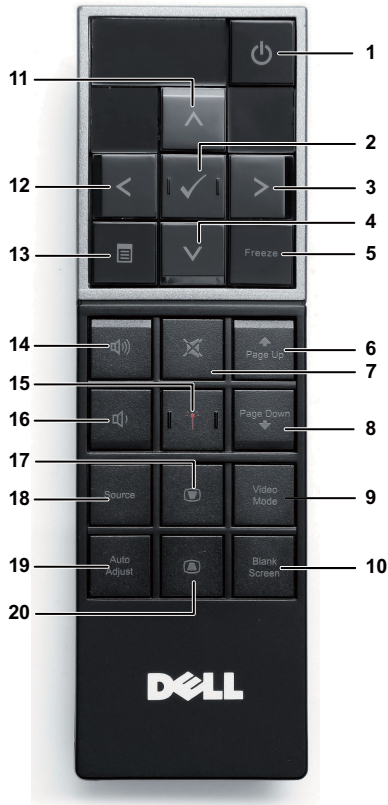









1	LAMP warning light	<p>If the LAMP amber indicator is on or blinking, one of the following problems could be occurring:</p> <ul style="list-style-type: none"> • Lamp is reaching its end of usable life • Lamp module is not properly installed • Lamp driver failure • Color wheel failure <p>For more information, see "Troubleshooting Your Projector" on page 41 and "Guiding Signals" on page 45.</p>
2	TEMP warning light	<p>If the TEMP amber indicator is on or blinking, one of the following problems could be occurring:</p> <ul style="list-style-type: none"> • Internal temperature of the projector is too high • Color wheel failure <p>For more information, see "Troubleshooting Your Projector" on page 41 and "Guiding Signals" on page 45.</p>
3	Power	<p>Turns the projector on or off. For more information, see "Turning Your Projector On" on page 14 and "Turning Your Projector Off" on page 14.</p>
4	Up  / Keystone adjustment	<p>Press to navigate through the On-Screen Display (OSD) Menu items.</p> <p>Press to adjust image distortion caused by tilting the projector (+40/-35 degrees).</p>
5	Right  / Auto Adjust	<p>Press to navigate through the On-Screen Display (OSD) Menu items.</p> <p>Press to synchronize the projector to the input source.</p> <p> NOTE: Auto Adjust does not operate if the on-screen display (OSD) is displayed.</p>
6	IR Receiver	<p>Point the remote control towards the IR receiver and press a button.</p>

7	Down  / Keystone adjustment	<p>Press to navigate through the On-Screen Display (OSD) Menu items.</p> <p>Press to adjust image distortion caused by tilting the projector (+40/-35 degrees).</p>
8	Menu 	<p>Press to activate the OSD. Use the directional keys and the Menu button to navigate through the OSD.</p>
9	Left  / Source	<p>Press to navigate through the On-Screen Display (OSD) Menu items.</p> <p>Press to toggle through Analog RGB, Composite, Component (YPbPr via VGA), HDMI, and S-video sources when multiple sources are connected to the projector.</p>
10	Enter 	<p>Press to confirm the selection item.</p>

Using the Remote Control



1	Power 	Turns the projector on or off. For more information, see "Turning Your Projector On" on page 14 and "Turning Your Projector Off" on page 14.
2	Enter 	Press to confirm the selection.
3	Right 	Press to navigate through the On-Screen Display (OSD) Menu items.
4	Down 	Press to navigate through the On-Screen Display (OSD) Menu items.

5	Freeze	Press to pause the screen image.
6	Page up 	Press to move to previous page.  NOTE: The USB cable must be connected if you want to use the Page Up feature.
7	Mute 	Press to mute or un-mute the projector speaker.
8	Page down 	Press to move to next page.  NOTE: The USB cable must be connected if you want to use the Page Down feature.
9	Video mode	The projector has preset configurations that are optimized for displaying data (presentation slides) or video (movies, games, etc.). Press the Video Mode button to toggle between Presentation mode , Bright mode , Movie mode , sRGB , or Custom mode . Pressing the Video Mode button once will show the current display mode. Pressing the Video Mode button again will switch between modes.
10	Blank screen	Press to hide/unhide the image.
11	Up 	Press to navigate through the On-Screen Display (OSD) Menu items.
12	Left 	Press to navigate through the On-Screen Display (OSD) Menu items.
13	Menu 	Press to activate the OSD.
14	Volume up 	Press to increase the volume.
15	Laser 	Point the remote control at the screen, press and hold the laser button to activate the laser light.  Caution: Do not look into the laser point when it is on. Avoid shining the laser light into eyes.
16	Volume down 	Press to decrease the volume.
17	Keystone adjustment 	Press to adjust image distortion caused by tilting the projector (+40/-35 degrees).
18	Source	Press to switch between Analog RGB, Composite, Component (YPbPr, via VGA), HDMI, and S-video sources.

19	Auto adjust	Press to synchronize the projector with the input source. Auto adjust does not operate if the OSD is displayed.
20	Keystone adjustment	Press to adjust image distortion caused by tilting the projector (+40/-35 degrees).



Installing the Remote Control Batteries

 **NOTE:** Remove the batteries from the remote control when not in use.

1 Press the tab to lift the battery compartment cover.



2 Check the polarity (+/-) marking on the batteries.



3 Insert the batteries and align their polarity correctly according to the marking in the battery compartment.



 **NOTE:** Avoid mixing different types of batteries or using new and old batteries together.

4 Slip the battery cover back.





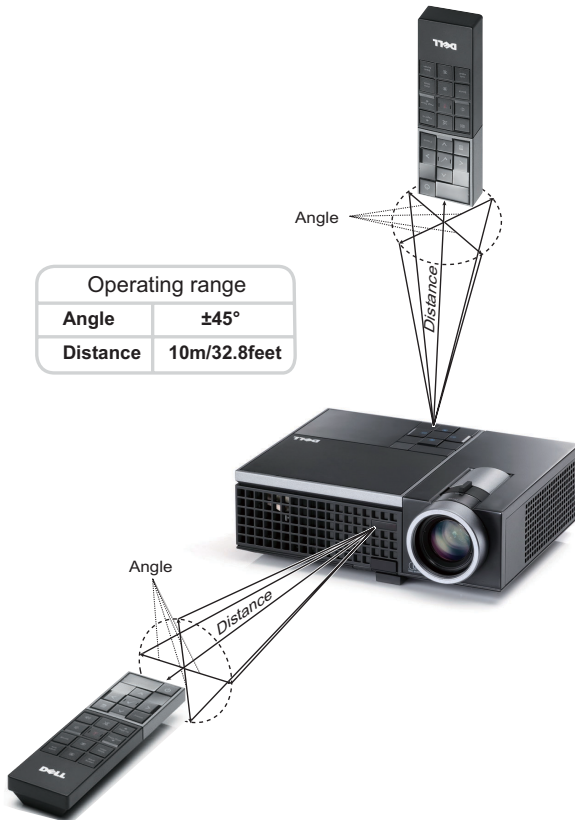





Operating Range With Remote Control



NOTE: Actual operating range may slightly differ from the diagram. Weak batteries will also prevent the remote control from properly operating the projector.

Using the On-Screen Display

- The projector has a multi-language On-Screen Display (OSD) Menu that can be displayed with or without an input source.
- To navigate through the tabs in the Main Menu, press the  or  buttons on your projector's control panel or remote control.
- To select a submenu, press the  button on your projector's control panel or remote control.
- To select an option, press the  or  buttons on your projector's control panel or remote control. The color changes to dark blue. When an item is selected, the color changes to dark blue.
- Use the  or  buttons on the control panel or remote control to adjust the settings.
- To go back to Main Menu, go to Back tab and press the  button on the control panel or the remote control.
- To exit the OSD, go to EXIT tab and press the  button or press the **Menu** button directly on the control panel or the remote control.

Main Menu



AUTO-ADJUST

Auto Adjust automatically adjusts the projector's **Frequency** and **Tracking** in PC mode. While Auto Adjustment is in progress, the following message appears on the screen:

Please wait...

INPUT SELECT

The Input Select menu allows you to select your projector's input source.

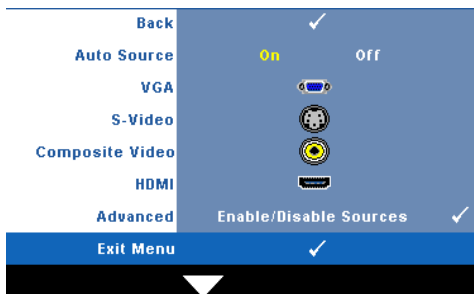

AUTO SOURCE—Select **Off** (the default) to lock the current input signal. If you press the **Source** button when the **Auto Source** mode is set to **Off**, you can manually select the input signal. Select **On** to auto detect the available input signals. If you press the **Source** button when the projector is on, it automatically finds the next available input signal.

VGA—Press to detect VGA signal.

S-VIDEO—Press to detect S-Video signal.

COMPOSITE VIDEO—Press to detect Composite Video signal.

HDMI—Press to detect HDMI signal.

ADVANCED—Press to activate **Input Select Advanced** menu.

INPUT SELECT ADVANCED

The Input Select Advanced menu allows you to enable or disable input sources.

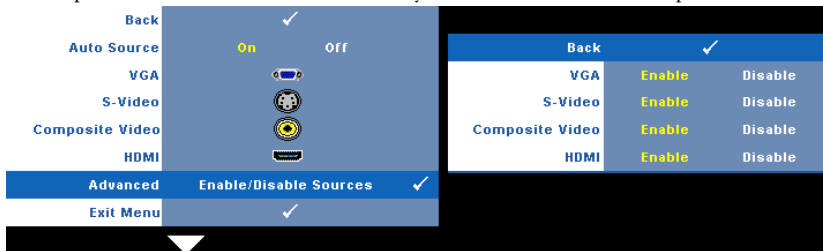

VGA—Use and to enable or disable VGA input.

S-VIDEO—Use and to enable or disable S-Video input.

COMPOSITE VIDEO—Use and to enable or disable Composite Video input.

HDMI—Use and to enable or disable HDMI input.



NOTE: You cannot disable your current input source. At anytime, a minimum of two input sources have to be enabled.



PICTURE (in PC Mode)

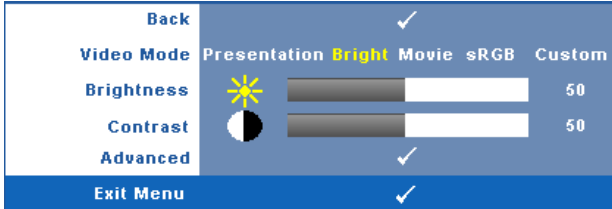

Using the **Picture** menu, you can adjust the display settings of your projector. The **Picture** menu, provides the following options:



VIDEO MODE—Allows you to optimize the display image: **Presentation**, **Bright**, **Movie**, **sRGB** (provides more accurate color representation), and **Custom** (set your preferred settings). If you adjust the settings for **Brightness**, **Contrast**, **Saturation**, **Sharpness**, **Tint**, and **Advanced**, the projector automatically switches to **Custom**.

 **NOTE:** If you adjust the settings for **Brightness**, **Contrast**, **Saturation**, **Sharpness**, **Tint**, and **Advanced** the projector automatically switches to **Custom**.

BRIGHTNESS—Use  and  to adjust the brightness of the image.

CONTRAST—Use  and  to adjust the display contrast.

ADVANCED—Press  to activate **Picture Advance** Menu. See "PICTURE ADVANCED" on page 29.

PICTURE (in Video Mode)

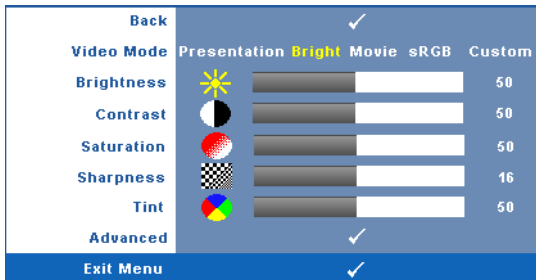

Using the **Picture** menu, you can adjust the display settings of your projector. The **Picture** menu provides the following options:







VIDEO MODE—Allows you to optimize the display image: **Presentation**, **Bright**, **Movie**, **sRGB** (provides more accurate color representation), and **Custom** (set your preferred settings). If you adjust the settings for **Brightness**, **Contrast**, **Saturation**, **Sharpness**, **Tint**, and **Advanced** the projector automatically switches

to Custom.



 **NOTE:** If you adjust the settings for **Brightness, Contrast, Saturation, Sharpness, Tint,** and **Advanced** the projector automatically switches to **Custom**.

BRIGHTNESS—Use  and  to adjust the brightness of the image.

CONTRAST—Use  and  to adjust the display contrast.

SATURATION—Allows you to adjust the video source from black and white to fully saturated color. Press  to decrease the amount of color in the image and  to increase the amount of color in the image.

SHARPNESS—Press  to decrease the sharpness and  to increase the sharpness.

TINT—Press  to increase the amount of green in the image and  to increase the amount of red in the image (available for NTSC only).



ADVANCED—Press  to activate **Picture Advance Menu**. See "PICTURE ADVANCED" below.

 **NOTE:** **Saturation, Sharpness,** and **Tint** are only available when input source is from Composite or S-Video.

PICTURE ADVANCED

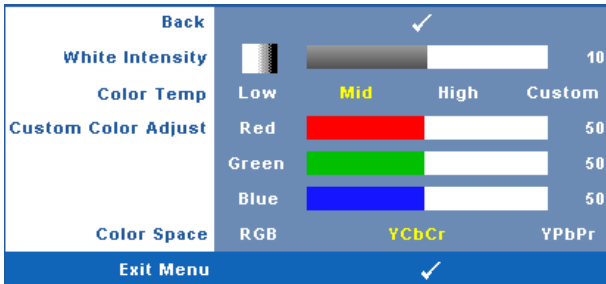
Using the Picture Advanced menu, you can adjust the display settings of your projector. The Picture Advanced menu provides the following options:



WHITE INTENSITY—Use  and  to adjust the display white intensity.

COLOR TEMP—Allows you to adjust the color temperature. The screen appears cooler at higher color temperatures and warmer at lower color temperatures. When you adjust the values in the **Color Adjust** menu, the Custom mode is activated. The values are saved in the Custom mode.

CUSTOM COLOR ADJUST—Allows you to manually adjust the colors red, green, and blue.

COLOR SPACE—Allows you to select the color space, options are: RGB, YCbCr, and YPbPr.

DISPLAY (in PC Mode)

Using the **Display** menu, you can adjust the display settings of your projector. The **Picture** menu provides the following options:

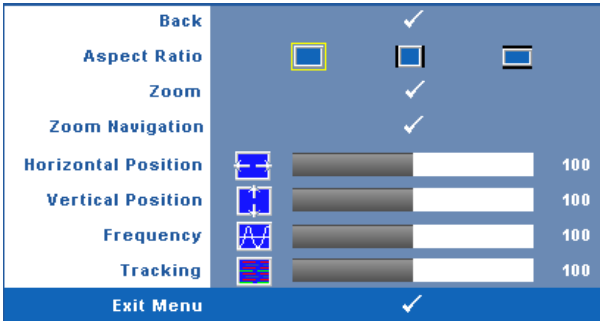

ASPECT RATIO—Allows you to select the aspect ratio to adjust how the image appears.

- Original — Select Original to maintain the aspect ratio of image projected according to input source.
- 4:3 — The input source scales to fit the screen and projects a 4:3 image.
- Wide — The input source scales to fit the width of the screen to project a wide screen image.

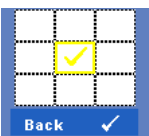

ZOOM—Press to activate **Zoom** menu.

Select the area to zoom and press to view zoomed image.

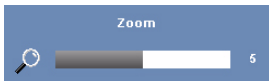



Adjust the image scale by pressing or and press to view.



ZOOM NAVIGATION—Press to activate **Zoom Navigation** menu.

Use , , , to navigate projection screen.

HORIZONTAL POSITION—Press to move the image to the left and to move the image to the right.

VERTICAL POSITION—Press  to move the image down and  to move the image up.

FREQUENCY—Allows you to change the display data clock frequency to match the frequency of your computer graphics card. If you see a vertical flickering wave, use Frequency control to minimize the bars. This is a coarse adjustment.



TRACKING—Synchronize the phase of the display signal with the graphic card. If you experience an unstable or flickering image, use Tracking to correct it. This is a fine adjustment.

DISPLAY (in Video Mode)

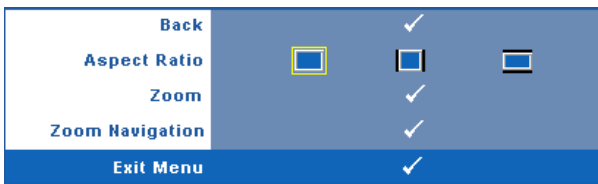
Using the Display menu, you can adjust the display settings of your projector. The Picture menu provides the following options:



ASPECT RATIO—Allows you to select the aspect ratio to adjust how the image appears.

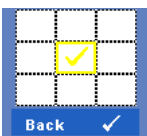

-  Original — Select Original to maintain the aspect ratio of image projected according to input source.
-  4:3 — The input source scales to fit the screen and projects a 4:3 image.
-  Wide — The input source scales to fit the width of the screen to project a wide screen image.



ZOOM—Press  to activate Zoom menu.

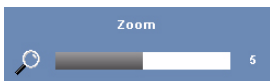



Select the area to zoom and press  to view zoomed image.



Adjust the image scale by pressing  or  and press  to view.



ZOOM NAVIGATION—Press  to activate Zoom Navigation menu.

Use     to navigate projection screen.

LAMP

Using the **Lamp** menu, you can adjust the display settings of your projector. The Lamp menu provides the following options:

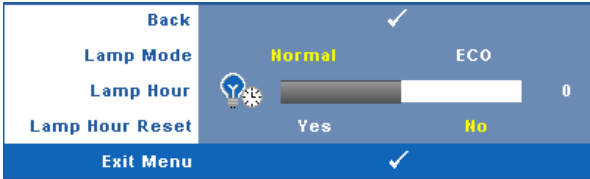

LAMP MODE—Allows you to select between Normal and ECO mode.

Normal mode operates at full power level. ECO Mode operates at a lower power level which may provide longer lamp life, quieter operation, and dimmer luminance output on the screen.

LAMP HOUR—Displays the operating hours since the last lamp timer reset.

LAMP HOUR RESET—Select **Yes** to reset the lamp timer.

SET UP

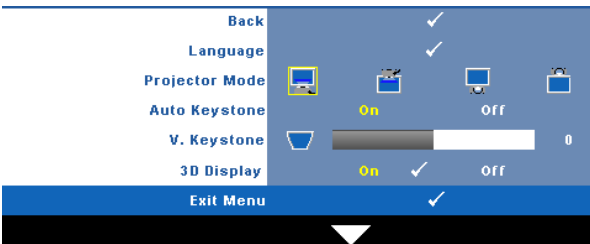

The Set Up menu allows you to adjust settings for Language, Projector Mode, Keystone, and 3D Display.



LANGUAGE—Allows you to set the language for the OSD. Press  to activate the Language menu.



PROJECTOR MODE—Allows you to select the projector mode, depending upon how the projector is mounted.

-  Front Projection-Desktop — This is the default option.
-  Rear Projection-Desktop — The projector reverses the image so that you can project from behind a translucent screen.

AUTO KEYSTONE—Select **On** to enable the auto correction for vertical image distortion caused by tilting the projector.

V. KEYSTONE—Manually adjust the vertical image distortion caused by tilting the projector.

3D DISPLAY—Select **On** to start the 3D display function. Default is **Off**.

 **NOTE:** To activate 3D Display function, ensure that 3D goggles, 3D video contents and 120Hz signal output graphic card supported on PC/NB are ready.



3D Sync Invert—If you see a discrete or overlapping image while wearing DLP 3D goggles, you may need to execute 'Invert' to get best match of left/right image sequence to get the correct image. (For DLP 3D goggles)

INFORMATION

The Information menu displays the current projector settings.

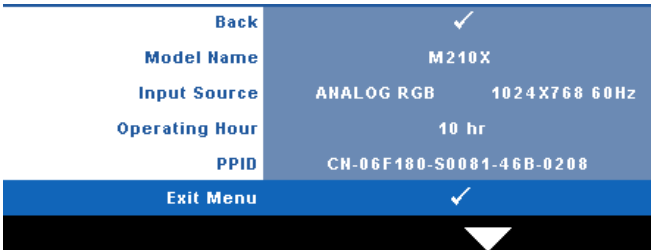

OTHERS

The Others menu allows you to change settings for Menu, Screen, Audio, Power, Security, and Closed Caption (for NTSC only). You can also perform Test Pattern and Factory Reset.

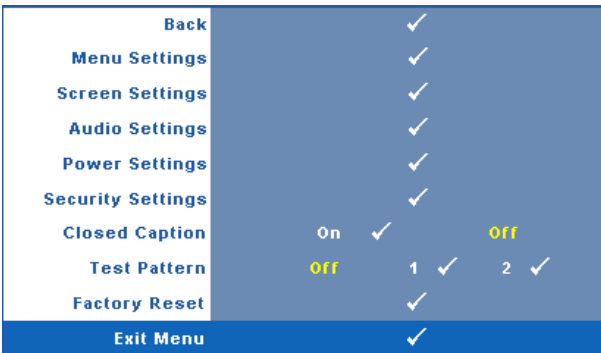

MENU SETTINGS—Select and press to activate menu settings. The menu settings consists of the following options:

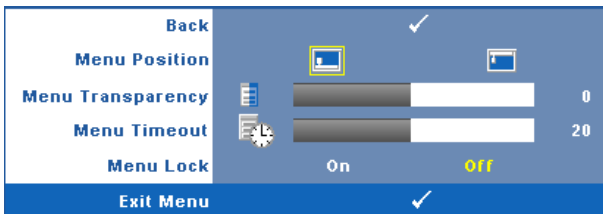

MENU POSITION—Allows you to change the position of the OSD menu on the screen.

MENU TRANSPARENCY—Select to change the transparency level of the OSD background.

MENU TIMEOUT—Allows you to adjust the time for an OSD timeout. By default, the OSD disappears after 20 seconds of non-activity.

MENU LOCK—Select **On** to enable Menu Lock and hide the OSD menu. Select **OFF** to disable the Menu Lock. If you want to disable the Menu Lock function and have the OSD disappear, press the **Menu** button on the control panel or remote control for 15 seconds, then disable the function.

SCREEN SETTINGS—Select and press to activate screen settings. The screen settings menu consists of the following options:



CAPTURE SCREEN—Select and press to capture the screen display, the following message appears on the screen.

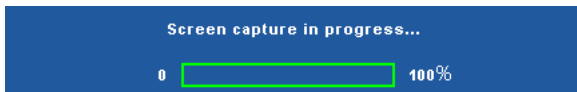

 **NOTE:** To capture a full image, ensure the input signal that is connected to the projector is 1024 x 768 resolution.



SCREEN—Select **Dell** to use the Dell logo as wallpaper. Select **Captured** to set the captured image as wallpaper.

RESET—Select and press to delete the captured picture and set back to the default setting.

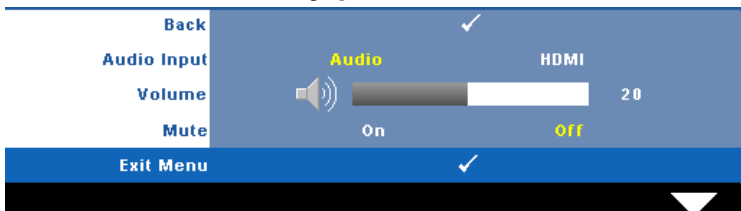
AUDIO SETTINGS—Select and press to change audio settings. The audio settings menu consists of the following options:



AUDIO INPUT—Select the Audio input source, options are: Audio and HDMI.

VOLUME—Press  to decrease the volume and  to increase the volume.

MUTE—Allows you to mute the sounds for audio input and audio output.

POWER SETTINGS—Select and press  to activate power settings. The power settings menu consists of the following options:

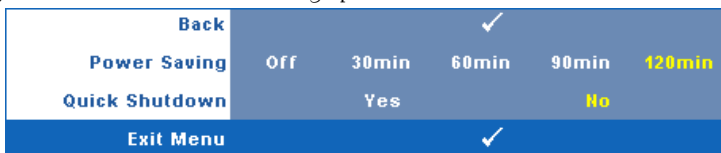

POWER SAVING—Select **Off** to disable Power Saving mode. By default, the projector is set to enter power saving mode after 120 minutes of no activity. A warning message appears on screen showing a 60-second countdown before switching to power saving mode. Press any button during countdown period to stop power saving mode.

You can also set a different delay period to enter power saving mode. The delay period is the time you want the projector to wait without an input signal. Power saving can be set to 30, 60, 90, or 120 minutes.

If an input signal is not detected during the delay period, the projector turns off the lamp and goes into power saving mode. If an input signal is detected within the delay period, the projector automatically turns on. If an input signal is not detected within two hours during power saving mode, the projector switches from Power Saving mode to Power Off mode. To turn on the projector press the Power button.

QUICK SHUTDOWN—Select **Yes** to turn off the projector with a single press of the **Power** button. This function allows the projector to quick power off with an accelerated fan speed. Slightly higher acoustic noise is expected during quick power off.



NOTE: Before you turn on the projector again, wait for 60 seconds to allow the internal temperature to stabilize. The projector will take a longer time to turn on if you try to power on immediately. Its cooling fan will run at full speed for about 30 seconds to stabilize the internal temperature.

SECURITY SETTINGS—Select and press  to activate security settings. The security settings menu allows you to enable and set password protection.

Back	✓
Password	Enable Off Delete
Change Password	✓
Exit Menu	✓

PASSWORD—When Password Protect is enabled, a Password Protect screen requesting you to enter a password will be displayed when the power plug is inserted into the electrical outlet and the power for the projector is first turned on. By default, this function is disabled. You can enable this feature by selecting **Enabled**. If the password has been set before, key in the password first and select the function. This password security feature will be activated the next time you turn on the projector. If you enable this feature, you will be asked to enter the projector's password after you turn on the projector:

1 First time password input request:

- a** Go to **Others** menu, press  and then select **Password** to **Enable** the password setting.

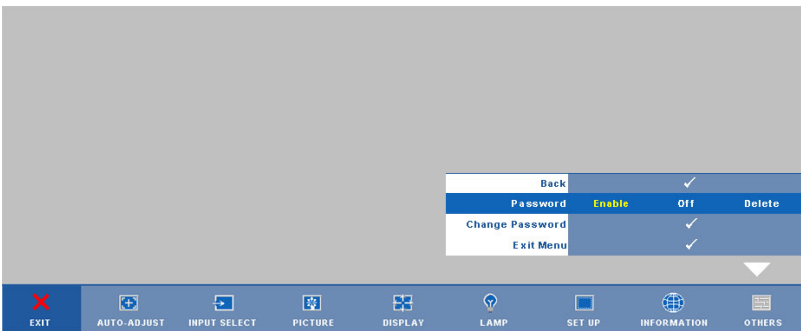

- b Enabling the Password function will pop up a character screen, key in a 4-digit number from the screen and press .

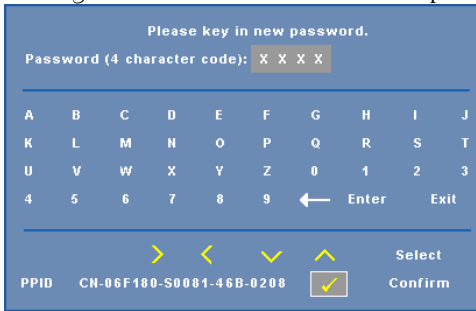

- c To confirm, enter the password again.
- d If the password verification is successful, you may resume with accessing the projector's functions and its utilities.
- 2 If you have entered an incorrect password, you will be given another 2 chances. After the three invalid attempts, the projector will automatically turn off.
-  **NOTE:** If you forget your password, contact DELL™ or qualified service personnel.
- 3 To disable the password function, select **Off** to disable the function.
- 4 To delete the password, select **Delete**.

CHANGE PASSWORD—Key in the original password, then enter the new password and confirm the new password again.

Please key in the original password.

Password (4 character code): X X X X

A	B	C	D	E	F	G	H	I	J
K	L	M	N	O	P	Q	R	S	T
U	V	W	X	Y	Z	0	1	2	3
4	5	6	7	8	9	←	Enter	Exit	

> < ✓ ⬆ Select
 PPID CN-06F180-S0081-46B-0208 ✓ Confirm

Please key in new password.

Password (4 character code): X X X X

A	B	C	D	E	F	G	H	I	J
K	L	M	N	O	P	Q	R	S	T
U	V	W	X	Y	Z	0	1	2	3
4	5	6	7	8	9	←	Enter	Exit	

> < ✓ ⬆ Select
 PPID CN-06F180-S0081-46B-0208 ✓ Confirm

Please key in new password again.

Password (4 character code): X X X X

A	B	C	D	E	F	G	H	I	J
K	L	M	N	O	P	Q	R	S	T
U	V	W	X	Y	Z	0	1	2	3
4	5	6	7	8	9	←	Enter	Exit	





> < ✓ ⬆ Select
 PPID CN-06F180-S0081-46B-0208 ✓ Confirm

CLOSED CAPTION—Select **On** to enable close caption and activate the closed caption menu. Select an appropriate closed captions option: CC1, CC2, CC3, and CC4.

Back	✓
Select	CC1 CC2 CC3 CC4
Exit Menu	✓

 **NOTE:** Closed caption option is available for NTSC only.

TEST PATTERN—Test Pattern is used to test focus and resolution.

You can enable or disable the **Test Pattern** by selecting **Off**, **1** or **2**. You can also invoke the **Test Pattern 1** by pressing and holding down  and  buttons on the control panel simultaneously for 2 seconds. You can also invoke the test pattern 2 by pressing and holding down  and  buttons on the control panel simultaneously for 2 seconds.

Test Pattern 1:

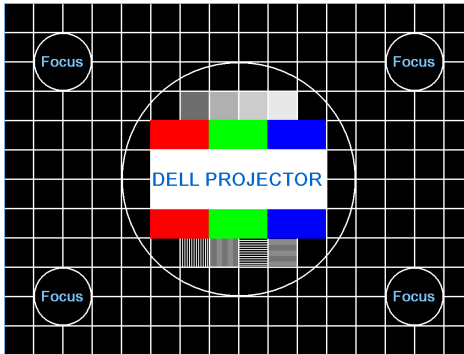

Test Pattern 2:



FACTORY RESET—Select and press  to reset all settings to its factory default, the warning message below appears.



Reset items include both computer sources and video source settings.

Troubleshooting Your Projector

If you experience problems with your projector, see the following troubleshooting tips. If the problem persists, contact Dell™. See *Contacting Dell™* on page 53.

Problem

No image appears on the screen

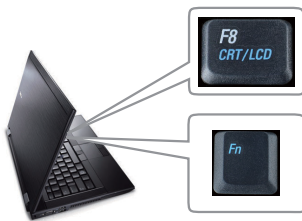





Possible Solution

- Ensure that the lens cap is removed and the projector is turned on.
- Ensure that the INPUT SELECT is set correctly in the OSD menu.
- Ensure the external graphics port is enabled. If you are using a Dell™ portable computer, press **Fn** **F8** (Fn+F8). For other computers, see your respective documentation. The output signal from the computer is not according to industry standards. Should this happen, upgrade the video driver of the computer. For Dell computer, see support.dell.com.
- Ensure that all the cables are securely connected. See "Connecting Your Projector" on page 8.
- Ensure that the pins of the connectors are not bent or broken.
- Ensure that the lamp is securely installed (see "Changing the Lamp" on page 47).
- Use **Test Pattern** in the **Others** menu. Ensure that the colors of the test pattern are correct.

Missing Input Source.
Cannot switch to particular
Input Source.

Go to Advanced Enable/Disable Sources,
ensure that particular Input Source is set to
Enable.

Problem (continued)	Possible Solution (continued)
Partial, scrolling, or incorrectly displayed image	<p>1 Press the Auto Adjust button on the remote control or the control panel.</p> <p>2 If you are using a Dell™ portable computer, set the resolution of the computer to XGA (1024 x 768):</p> <ul style="list-style-type: none"> a Right-click the unused portion of your Microsoft® Windows® desktop, click Properties and then select Settings tab. b Verify that the setting is 1024 x 768 pixels for the external monitor port. c Press   (Fn+F8).
	<p>If you experience difficulty in changing resolutions or your monitor freezes, restart all the equipment and the projector.</p>
	<p>If you are not using a Dell™ portable computer, see your documentation. The output signal from the computer may not be according to industry standards. Should this happen, upgrade the video driver of the computer. For a Dell computer, see support.dell.com.</p>
The screen does not display your presentation	<p>If you are using a portable computer, press   (Fn+F8).</p>
Image is unstable or flickering	<p>Adjust the tracking in the OSD Display sub-menu (in PC Mode only).</p>
Image has vertical flickering bar	<p>Adjust the frequency in the OSD Display sub-menu (in PC Mode only).</p>
Image color is incorrect	<ul style="list-style-type: none"> • If the display receives the wrong signal output from the graphics card, please set the signal type to RGB in the OSD Display tab. • Use Test Pattern in the Others menu. Ensure that the colors of the test pattern are correct.

Problem (continued)	Possible Solution (continued)
Image is out of focus	<ol style="list-style-type: none"> 1 Adjust the focus ring on the projector lens. 2 Ensure that the projection screen is within the required distance from the projector (3.28 ft [1 m] to 39.37 ft [12 m]).
The image is stretched when displaying a 16:9 DVD	<p>The projector automatically detects the input signal format. It will maintain the aspect ratio of the projected image according to input signal format with an Original setting.</p> <p>If the image is still stretched, adjust the aspect ratio in the Set Up menu in the OSD.</p>
Image is reversed	Select Set Up from the OSD and adjust the projector mode.
Lamp is burned out or makes a popping sound	When the lamp reaches its end of life, it may burn out and may make a loud popping sound. If this occurs, the projector does not turn back on. To replace the lamp, see "Changing the Lamp" on page 47.
LAMP light is solid amber	If the LAMP light is solid amber, replace the lamp.
LAMP light is blinking amber	<p>If the LAMP light is blinking amber, Lamp module connection may be disrupted. Please check the lamp module and ensure that it is properly installed.</p> <p>If the LAMP light and the Power light are blinking amber, the lamp driver has failed and the projector will automatically shut down.</p> <p>If the LAMP and TEMP light are blinking amber and the Power light is solid blue, the color wheel has failed and the projector will automatically shut down.</p> <p>To clear the protection mode, press and hold the POWER button for 10 seconds.</p>
TEMP light is solid amber	The projector has overheated. The display automatically shuts down. Turn the display on again after the projector cools down. If the problem persists, contact Dell™.

Problem (continued)	Possible Solution (continued)
TEMP light is blinking amber	A projector fan has failed and the projector will automatically shut down. Try to clear the projector mode by pressing and holding the POWER button for 10 seconds. Please wait for about 5 minutes and try to power up again. If the problem persists, contact Dell™.
The OSD does not appear on the screen	Try to press the Menu button on the panel for 15 seconds to unlock the OSD. Check the Menu Lock on page 36.
The remote control is not operating smoothly or works only within a limited range	The battery may be low. Check if the laser beam transmitted from the remote is too dim. If so, replace with 2 new AAA batteries.

Guiding Signals

Projector Status	Description	Control Buttons			Indicator	
		Power	Menu	Others	TEMP (Amber)	LAMP (Amber)
Standby mode	Projector in Standby mode. Ready to power on.	BLUE Flashing	OFF	OFF	OFF	OFF
Warming up mode	Projector takes some time to warm up and power on.	BLUE	BLUE	BLUE	OFF	OFF
Lamp on	Projector in Normal mode, ready to display an image.  Note: The OSD menu is not accessed.	BLUE	BLUE	OFF	OFF	OFF
Cooling mode	Projector is cooling to shutdown.	BLUE	OFF	OFF	OFF	OFF
Power Saving mode	Power Saving mode has been activated. The projector will automatically enter standby mode, if an input signal is not detected in two hours.	AMBER Flashing	OFF	OFF	OFF	OFF
Cooling before Power Saving mode	The projector takes 60 seconds to cool down before entering Power Saving mode.	AMBER	OFF	OFF	OFF	OFF
Projector overheated	Air vents might be blocked or ambient temperature may be above 35°C. The projector automatically shuts down. Ensure that the air vents are not blocked and that the ambient temperature is within operational range. If the problem persists, contact Dell.	OFF	OFF	OFF	AMBER	OFF
Lamp overheated	The lamp is overheated. The air vents may be blocked. The projector automatically shuts down. Turn the display on again after the projector cools down. If the problem persists, contact Dell.	BLUE	OFF	OFF	AMBER	OFF
Lamp driver overheated	The lamp driver is overheated. The air vents may be blocked. The projector automatically shuts down. Turn the display on again after the projector cools down. If the problem persists, contact Dell.	AMBER	OFF	OFF	AMBER	OFF
Fan breakdown	One of the fans has failed. The projector automatically shuts down. If the problem persists, contact Dell.	OFF	OFF	OFF	AMBER Flashing	OFF
Lamp driver breakdown	The lamp driver has failed. The projector automatically shuts down. Unplug the power cord after three minutes then turn the display on again. If this problem persists, contact Dell.	AMBER Flashing	OFF	OFF	OFF	AMBER Flashing
Color Wheel breakdown	Color wheel cannot start. The projector has failed and the projector automatically shuts down. Unplug the power cord after three minutes and then turn on the projector. If this problem persists, contact Dell.	BLUE	OFF	OFF	AMBER Flashing	AMBER Flashing

Lamp failure	Lamp is defective. Replace the lamp.	OFF	OFF	OFF	OFF	AMBER
Lamp module connection failed	Lamp module connection may be disrupted. Check the lamp module and ensure that it is properly installed. If the problem persists, contact Dell.	OFF	OFF	OFF	OFF	AMBER Flashing

Changing the Lamp

⚠ CAUTION: Before you begin any of the procedures in this section, follow the Safety Instructions as described on page 6.

Replace the lamp when the message "**Lamp is approaching the end of its useful life in the operation. Replacement suggested!** www.dell.com/lamps" appears on the screen. If this problem persists after replacing the lamp, contact Dell™. For more information, see Contacting Dell™ on page 53.

⚠ CAUTION: Use an original lamp to ensure safe and optimal working condition of your projector.

⚠ CAUTION: The lamp becomes very hot when in use. Do not attempt to replace the lamp until the projector has been allowed to cool down for at least 30 minutes.

⚠ CAUTION: Do not touch the bulb or the lamp glass at any time. Projector lamps are very fragile and may shatter if touched. The shattered glass pieces are sharp and can cause injury.

⚠ CAUTION: If the lamp shatters, remove all broken pieces from the projector and dispose or recycle according to state, local, or federal law. For more information see www.dell.com/hg.

- 1 Turn off the projector and disconnect the power cord.
- 2 Let the projector cool for at least 30 minutes.
- 3 Loosen the two screws that secure the lamp cover, and remove the cover.
- 4 Loosen the two screws that secure the lamp.
- 5 Pull the lamp up by its metal handle.

✍ NOTE: Dell™ may require lamps replaced under warranty to be returned to Dell™. Otherwise, contact your local waste disposal agency for the address of the nearest deposit site.

- 6 Replace with the new lamp.
- 7 Tighten the two screws that secure the lamp.
- 8 Replace the lamp cover and tighten the two screws.



9 Reset the lamp usage time by selecting "Yes" for **Lamp Reset** in the **OSD Lamp** tab (see **Lamp** menu on page 32). When a new lamp module has been changed, the projector will automatically detect and reset the lamp hours.



CAUTION: Lamp Disposal (for the US only)

 **LAMP(S) INSIDE THIS PRODUCT CONTAIN MERCURY AND MUST BE RECYCLED OR DISPOSED OF ACCORDING TO LOCAL, STATE OR FEDERAL LAWS. FOR MORE INFORMATION, GO TO WWW.DELL.COM/HG OR CONTACT THE ELECTRONIC INDUSTRIES ALLIANCE AT WWW.EIAE.ORG. FOR LAMP SPECIFIC DISPOSAL INFORMATION CHECK WWW.LAMPRECYCLE.ORG.**

Specifications

Light Valve	0.55" XGA S450 DMD, DarkChip3™
Brightness	2000 ANSI Lumens (Max.)
Contrast Ratio	2100:1 Typical (Full On/Full Off)
Uniformity	85% Typical (Japan Standard - JBMA)
Number of Pixels	1024 x 768 (XGA)
Displayable Color	1.07 billion colors
Color Wheel Speed	2X
Projection Lens	F-Stop: F/ 2.41~2.55 Focal length, f=21.8~24 mm 1.1X manual Zoom Lens Throw ratio = 1.95~2.15 wide and tele
Projection Screen Size	22.89-302.8 inches (diagonal)
Projection Distance	3.28~39.37 ft (1 m ~ 12 m)
Video Compatibility	Composite Video / S-Video: NTSC (J, M, 4.43), PAL (B, D, G, H, I, M, N, Nc, 60), SECAM (B, D, G, K, K1, L) Component Video via VGA & HDMI: 1080i/p, 720p, 576i/p, 480i/p
Power Supply	Universal AC 100-240 50-60 Hz with PFC input
Power Consumption	Normal mode: 210W ± 10% @ 110Vac Eco mode: 166W ± 10% @ 110Vac Power saving mode: <12W Standby mode: < 1W
Audio	1 speaker x 1 watt RMS
Noise Level	39 dB(A) Normal mode, 32 dB(A) Eco mode
Weight	2.6 lbs (1.18 kg)

Dimensions (W x H x D) 8.07 x 2.99 x 6.10 inches (205 x 75.9 x 155 mm)



Environmental	<p>Operating temperature: 5°C - 35°C (41°F- 95°F) Humidity: 80% maximum</p> <p>Storage temperature: 0°C to 60°C (32°F to 140°F) Humidity: 90% maximum</p> <p>Shipping temperature: -20°C to 60°C (-4°F to 140°F) Humidity: 90% maximum</p>
I/O Connectors	<p>Power: One AC power socket (3-pin - C14 inlet)</p> <p>VGA input: One 15-pin D-sub connector (Blue), for analog RGB/Component input signals.</p> <p>S-Video input: One standard 4-pin min-DIN S-Video connector for Y/C signal.</p> <p>Composite video input: One Yellow RCA jack for CVBS signal.</p> <p>HDMI input: One HDMI connector for supporting HDMI 1.3. HDCP compliant.</p> <p>Analog Audio input: One 3.5 mm stereo mini phone jack (Blue).</p> <p>Variable audio output: One 3.5 mm stereo mini phone jack (Green).</p> <p>USB port: One USB slave for remote support.</p>
Lamp	<p>OSRAM 165 W user-replaceable lamp (up to 5000 hours in eco mode)</p>



NOTE: The lamp life rating for any projector is a measure of brightness degradation only, and is not a specification for the time it takes a lamp to fail and cease light output. Lamp life is defined as the time it takes for more than 50 percent of a lamp sample population to have brightness decrease by approximately 50 percent of the rated lumens for the specified lamp. The lamp life rating is not guaranteed in any way. The actual operating life span of a projector lamp will vary according to operating conditions and usage patterns. Usage of a projector in stressful conditions which may include dusty environments, under high temperatures, many hours per day and abrupt powering-off will most likely result in a lamp's shortened operating life span or possible lamp failure.

Compatibility Modes (Analog/Digital)

Resolution	Refresh Rate (Hz)	Hsync Frequency (KHz)	Pixel Clock (MHz)
640 x 350	70.087	31.469	25.175
640 x 480	59.940	31.469	25.175
640 x 480 p60	59.940	31.469	25.175
720 x 480 p60	59.940	31.469	27.000
720 x 576 p50	50.000	31.250	27.000
720 x 400	70.087	31.469	28.322
640 x 480	75.000	37.500	31.500
848 x 480	60.000	31.020	33.750
640 x 480	85.008	43.269	36.000
800 x 600	60.317	37.879	40.000
800 x 600	75.000	46.875	49.500
800 x 600	85.061	53.674	56.250
1024 x 768	60.004	48.363	65.000
1280 x 720 p50	50.000	37.500	74.250
1280 x 720 p60	60.000	45.000	74.250
1920 x 1080 i50	50.000	28.125	74.250
1920 x 1080 i60	60.000	33.750	74.250
1280 x 720	59.855	44.772	74.500
1024 x 768	75.029	60.023	78.750
1280 x 800	59.810	49.702	83.500
1366 x 768	59.790	47.712	85.500
1360 x 768	60.015	47.712	85.500
1024 x 768	84.997	68.677	94.500
1440 x 900	59.887	55.935	106.500
1152 x 864	75.000	67.500	108.000
1280 x 960	60.000	60.000	108.000
1280 x 1024	60.020	63.981	108.000
1152 x 864	85.000	77.095	119.651
1400 x 1050	59.978	65.317	121.750
1280 x 800	84.880	71.554	122.500
1280 x 1024	75.025	79.976	135.000
1440 x 900	74.984	70.635	136.750
1680 x 1050	59.954	65.290	146.250
1280 x 960	85.002	85.938	148.500
1920 x 1080	60.000	67.500	148.500
1400 x 1050	74.867	82.278	156.000
1280 x 1024	85.024	91.146	157.000
1440 x 900	84.842	80.430	157.000
1600 x 1200	60.000	75.000	162.000

Contacting Dell

For customers in the United States, call 800-WWW-DELL (800-999-3355).



NOTE: If you do not have an active Internet connection, you can find contact information on your purchase invoice, packing slip, bill, or Dell product catalog.

Dell™ provides several online and telephone-based support and service options. Availability varies by country and product, and some services may not be available in your area. To contact Dell for sales, technical support, or customer service issues:

- 1 Visit support.dell.com.
- 2 Verify your country or region in the **Choose A Country/Region** drop-down menu at the bottom of the page.
- 3 Click **Contact Us** on the left side of the page.
- 4 Select the appropriate service or support link based on your need.
- 5 Choose the method of contacting Dell that is convenient for you.

Appendix: Glossary

ANSI LUMENS — A standard for measuring the brightness. It is calculated by dividing a square meter image into nine equal rectangles, measuring the lux (or brightness) reading at the center of each rectangle, and averaging these nine points.

ASPECT RATIO — The most popular aspect ratio is 4:3 (4 by 3). Early television and computer video formats are in a 4:3 aspect ratio, which means that the width of the image is $\frac{4}{3}$ times the height.

Brightness — The amount of light emitting from a display or projection display or projection device. The brightness of projector is measured by ANSI lumens.

Color Temperature — The color appearance of white light. Low color temperature implies warmer (more yellow/red) light while high color temperature implies a colder (more blue) light. The standard unit for color temperature is Kelvin (K).

Component Video — A method of delivering quality video in a format that consists of the luminance signal and two separate chrominance signals and are defined as Y'Pb'Pr' for analog component and Y'Cb'Cr' for digital component. Component video is available on DVD players.

Composite Video — A video signal that combines the luma (brightness), chroma (color), burst (color reference), and sync (horizontal and vertical synchronizing signals) into a signal waveform carried on a single wire pair. There are three kinds of formats, namely, NTSC, PAL, and SECAM.

Compressed Resolution — If the input images are of higher resolution than the native resolution of the projector, the resulting image will be scaled to fit the native resolution of the projector. The nature of compression in a digital device means that some image content is lost.

Contrast Ratio — Range of light and dark values in a picture, or the ratio between their maximum and minimum values. There are two methods used by the projection industry to measure the ratio:

- 1 *Full On/Off* — measures the ratio of the light output of an all white image (full on) and the light output of an all black (full off) image.
- 2 *ANSI* — measures a pattern of 16 alternating black and white rectangles. The average light output from the white rectangles is divided by the average light output of the black rectangles to determine the ANSI contrast ratio.

Full On/Off contrast is always a larger number than ANSI contrast for the same projector.

dB — decibel — A unit used to express relative difference in power or intensity, usually between two acoustic or electric signals, equal to ten times the common logarithm of the ratio of the two levels.

Diagonal Screen — A method of measuring the size of a screen or a projected image. It measures from one corner to the opposite corner. A 9 ft high, 12 ft wide, screen has a diagonal of 15 ft. This document assumes that the diagonal dimensions are for the traditional 4:3 ratio of a computer image as per the example above.

DLP® — Digital Light Processing™ — Reflective display technology developed by Texas Instruments, using small manipulated mirrors. Light passing through a color filter is sent to the DLP mirrors which arrange the RGB colors into a picture projected onto screen, also known as DMD.

DMD — Digital Micro-Mirror Device — Each DMD consists of thousands of tilting, microscopic aluminum alloy mirrors mounted on a hidden yoke.

Focal Length — The distance from the surface of a lens to its focal point.

Frequency — It is the rate of repetition in cycles per seconds of electrical signals. Measured in Hz (Hertz).

HDCP — High-Bandwidth Digital-Content Protection — A specification developed by Intel™ Corporation to protect digital entertainment across digital interface, such as DVI and HDMI.

HDMI — High-Definition Multimedia Interface — HDMI carries both uncompressed high definition video along with digital audio and device control data in a single connector.

Hz (Hertz) — Unit of frequency.

Keystone Correction — Device that will correct an image of the distortion (usually a wide-top narrow-bottom effect) of a projected image caused by improper projector to screen angle.

Maximum Distance — The distance from a screen the projector can be to cast an image that is usable (bright enough) in a fully darkened room.

Maximum Image Size — The largest image a projector can throw in a darkened room. This is usually limited by focal range of the optics.

Minimum Distance — The closest position that a projector can focus an image onto a screen.

NTSC — National Television Standards Committee. North American standard for video and broadcasting, with a video format of 525 lines at 30 frames per second.

PAL — Phase Alternating Line. A European broadcast standard for video and broadcasting, with a video format of 625 lines at 25 frames per second.

Reverse Image — Feature that allows you to flip the image horizontally. When used in a normal forward projection environment text, graphics, etc. are backwards. Reverse image is used for rear projection.

RGB — Red, Green, Blue — typically used to describe a monitor that requires separate signals for each of the three colors.

S-Video — A video transmission standard that uses a 4-pin mini-DIN connector to send video information on two signal wires called luminance (brightness, Y) and chrominance (color, C). S-Video is also referred to as Y/C.

SECAM — A French and international broadcast standard for video and broadcasting, closely related to PAL but with a different method of sending color information.

SVGA — Super Video Graphics Array — 800 x 600 pixels count.

SXGA — Super Extended Graphics Array, — 1280 x 1024 pixels count.

UXGA — Ultra Extended Graphics Array — 1600 x 1200 pixels count.

VGA — Video Graphics Array — 640 x 480 pixels count.

XGA — Extended Video Graphics Array — 1024 x 768 pixels count.

Zoom Lens — Lens with a variable focal length that allows operator to move the view in or out making the image smaller or larger.

Zoom Lens Ratio — Is the ratio between the smallest and largest image a lens can project from a fixed distance. For example, a 1.4:1 zoom lens ratio means that a 10 foot image without zoom would be a 14 foot image with full zoom.

Index

A

- Adjusting the Projected Image 15
 - Adjusting the Projector Height 15
 - lower the projector
 - Elevator button 15
 - Elevator foot 15
 - Tilt adjustment wheel 15
- Adjusting the Projector Zoom and Focus 16
 - Focus ring 16
 - Zoom tab 16
- Audio 8
- Audio Input 36
- Audio Settings 35

C

- Capture Screen 35
- Changing the Lamp 47
- Closed Caption 39
- Connecting the Projector
 - Composite video cable 11
 - Connecting with a Component Cable 12
 - Connecting with a Composite Cable 11
 - Connecting with an HDMI Cable 13
 - Connecting with an S-video

Cable 10

- HDMI cable 13
 - Power cord 9, 10, 11, 12, 13
 - S-video cable 10
 - To Computer 9
 - USB to USB cable 9
 - VGA to VGA cable 9
 - VGA to YPbPr cable 12
- Connection Ports
- Composite video connector 8
 - S-video connector 8
 - USB remote connector 8
 - VGA input (D-sub) connector 8
- Contact Dell 5, 43, 47
- Control Panel 18

D

- Dell
 - contacting 53

M

- Main Unit 6
 - Control panel 6
 - Elevator button 6
 - Focus ring 6
 - IR receiver 6
 - Lens 6
 - Zoom tab 6
- Menu Position 34

- Menu Settings 34
- Menu Timeout 35
- Menu Transparency 35
- Mute 36

O

- On-Screen Display 26
 - Auto-Adjust 28
 - Display (in PC Mode) 30
 - Display (in Video Mode) 31
 - Input Select 27
 - Lamp 32
 - Main Menu 26
 - Others 34
 - Picture (in PC Mode) 28
 - Picture (in Video Mode) 28
 - Set Up 32

P

- Password 37
- phone numbers 53
- Power Saving 36
- Power Settings 36
- Powering On/Off the Projector
 - Powering Off the Projector 14
 - Powering On the Projector 14

Q

- Quick Shutdown 36

R

- Remote Control 21
 - IR receiver 19
- Reset 35
- Reset, Factory 40

S

- Screen 35
- Screen Settings 35
- Security Settings 37
- Specifications
 - Audio 49
 - Brightness 49
 - Color Wheel Speed 49
 - Contrast Ratio 49
 - Dimensions 50
 - Displayable Color 49
 - Environmental 50
 - I/O Connectors 50
 - Lamp 50
 - Light Valve 49
 - Noise Level 49
 - Number of Pixels 49
 - Power Consumption 49
 - Power Supply 49
 - Projection Distance 49
 - Projection Lens 49
 - Projection Screen Size 49
 - Uniformity 49
 - Video Compatibility 49
 - Weight 49

- support
 - contacting Dell 53

T

telephone numbers 53

Test Pattern 40

Troubleshooting 41

 Contact Dell 41

V

Volume 36